

# **SERIES H1W ACCESS COVER**

## **With Grating Panel**

### **TABLE OF CONTENTS**

**V e n d o r   D a t a**

**M a t e r i a l   D a t a   S h e e t**

**S p e c i f i c a t i o n**

**C o m p o n e n t   P a r t s   L i s t**

**Storage, Handling, Installation & Maintenance Instructions**

**Limited Warranty**

**VENDOR DATA**

**HALLIDAY PRODUCTS, INC.  
6401 Edgewater Drive  
Orlando, FL 32810**

**Phone: 407-298-4470 - Fax: 407-298-4534**

**Toll Free: 800-298-1027**

**Email: [marketing@HallidayProducts.com](mailto:marketing@HallidayProducts.com)**

**Web Site at [www.HallidayProducts.com](http://www.HallidayProducts.com)**

**Armond Bordeau, Contact**

## **MATERIAL DATA SHEET**

### Access Frame and Cover with Grating Panel

1. Door leaf shall be ¼-in. thick 5086-H34\* mill finish aluminum diamond pattern plate.
2. Frame members shall be ¼-in. thick 6063-T5 mill finish aluminum extrusion.
3. The following items shall be Type 316 Stainless Steel: hinges, hold-open arm, slam lock and all attaching hardware.
4. Grating aluminum "I" bar construction
5. Tamper proof stainless steel hinge bolts
6. Units shall carry a Lifetime Guarantee against defects in material and/or workmanship.

\*5086-H34 has excellent resistance to corrosion--especially in a marine environment, good workability, weld ability, good finishing characteristics, and higher strength than 3003 or 5052.

## **Series H1W Access Frame and Cover with Grating Panel**

### **STANDARD FEATURES:**

Stainless steel compression spring assist  
Auto-lock, T316 stainless steel hold-open arm with release handle  
T-316 stainless steel hinges and attaching hardware  
T-316 stainless steel slam lock w/ removable key  
Single or double leaf construction  
Channel frame  
View area for observation and limited maintenance  
Safety Orange powder-coated finish  
H-20 load rating (See Note)

### **SPECIFICATION:**

The H1W (single leaf) access frame and cover as manufactured by Halliday Products, Inc. of Orlando, Florida shall have a ¼- in. thick one-piece, mill finish, extruded aluminum channel frame, incorporating a continuous concrete anchor. A 1-½-in. drainage coupling shall be located in the front left corner of the channel frame. The inside of the frame shall have a door-support ledge on two (2) sides. Both frame and ledge must be supported by a full bed of Class A concrete. The door panel(s) shall be ¼-in. aluminum diamond plate. Door(s) shall open to 90 degrees and automatically lock with (a) T-316 stainless steel hold-open arm(s) with aluminum release handle(s). For ease of operation door(s) shall incorporate enclosed stainless steel compression spring assist. Door(s) shall close flush with the frame. Hinges and all fastening hardware shall be T-316 stainless steel. Unit shall lock with T-316 stainless steel slam lock with removable keys. The protective grating panel shall be 3 inch (76mm) aluminum "I" bar grating designed for H20 load with Safety Orange powder-coated finish. Grating shall be hinged with tamper proof stainless steel bolts, and shall be supplied with a positive latch to maintain unit in an upright position. Grating shall have a 6-in. (152mm) viewing area on each lateral unhinged side for visual observation and limited maintenance. A padlock hasp for owner-supplied padlock shall be provided. Unit shall carry a Lifetime guarantee against defects in material and/or workmanship.

**NOTE:** The Series H1W is suitable for use in off-street locations where not subjected to traffic.



**SERIES HIW**

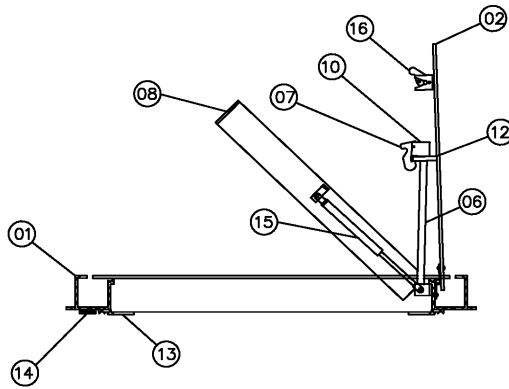
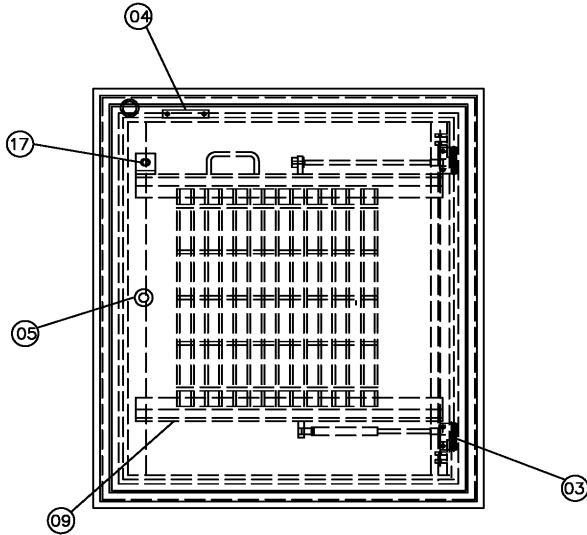

**STANDARD COMPONENT PARTS**

- ① FRAME EXTRUSION
- ② DIAMOND PLATE COVER
- ③ HINGES W/ HARDWARE
- ④ LIFTING HANDLE
- ⑤ SLAM LOCK
- ⑥ HOLD-OPEN ARM
- ⑦ POSITIVE LOCKING LATCH
- ⑧ GRATING PANEL
- ⑨ GRATING BEAM
- ⑩ UPPER CLEVIS ASSEMBLY
- ⑪ LOWER CLEVIS ASSEMBLY
- ⑫ GUIDE PLATE
- ⑬ Z BAR
- ⑭ DRAIN
- ⑮ SPRING
- ⑯ GRATING LATCH
- ⑰ GRATING LOCK PAD

**NOTE:** Component Part Pricing:

Due to component part sizes and pricing change, Halliday Products Inc. does not list component part pricing. Halliday Products Inc. has a Limited Life Time Warranty on parts. See Warranty



**SERIES H1W GRATING OPTIONS**

- (A) KEYED CYLINDER LOCK
- (B) RECESSED LOCK BOX
- (C) SLAB SKIRTING
- (D) GASKET
- (E) BOLT DOWN

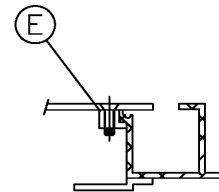
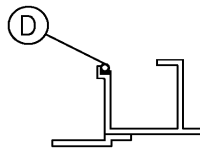
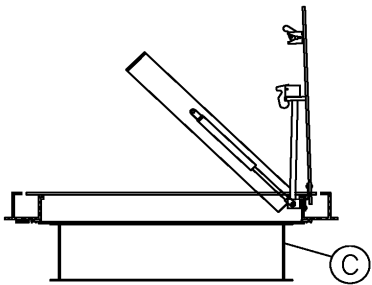
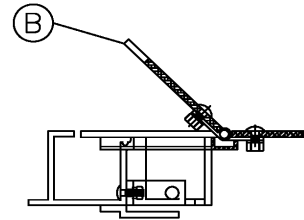
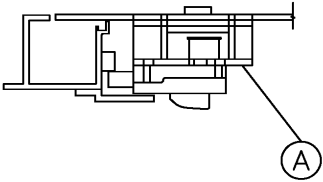

**NOTE:** Component Part Pricing:

Due to component part sizes and pricing change, Halliday Products Inc. does not list component part pricing. Halliday Products Inc. has a Limited Life Time Warranty on parts. See Warranty

## **STORAGE, HANDLING, INSTALLATION and MAINTENANCE**

### **STORAGE:**

Prior to installation, access covers should be stored in a dry area on the original shipping pallets.

### **HANDLING:**

Standard practice precautions should be taken whenever handling or moving palletized access covers by forklift.

### **INSTALLATION:**

For proper installation, Halliday Products, Inc. recommends the following:

1. Formwork must be flush to the inside of frame of the support ledge. The entire frame and ledge must be supported with Class A concrete.
2. Secure unit to formwork using standard construction practices.
3. When pouring concrete, cover should be in the closed position.
4. Concrete to finish flush with top of unit framework.
5. Unit should be left in formwork for not less than 24 hours.
6. Clean all excess concrete from frame, over seat; and in the case of a channel frame model, the drainage coupling.

### **MAINTENANCE:**

Because access covers manufactured by Halliday Products, Inc. are of all aluminum and stainless steel construction, they require minimal maintenance. For optimum product life the manufacturer recommends the following procedures be performed annually:

1. Apply graphite to the interior of all locking devices.
2. Apply a light coating of machine oil to all hinges and hardware.
3. Remove all debris from the cover seat and around hinges.
4. Check and tighten any loose hardware.
5. In the case of a channel frame model, remove loose debris from channel.



## LIMITED WARRANTY

Halliday Products, Inc., a Florida Corporation (“Company”) warrants to the original customer the aluminum access frame and cover will be free from defective material or faulty workmanship for the life of the unit. In the event of malfunction or other indication of failure attributable directly to defective material or faulty workmanship, Company will, upon receipt of a written notification from customer of such defective material or faulty workmanship, at its option and expense, repair or replace the defective frame and cover, or a component thereof, to whatever extent Company shall deem necessary to restore the frame and cover, or a component thereof, to proper operating condition. Company may replace the defective frame and cover, or a component thereof, with either a new or remanufactured, functionally equivalent frame and cover or component thereof at the Company’s option. **THIS WARRANTY IS EXCLUSIVE AND IN LIEU OF ALL OTHER WARRANTIES, WHETHER OR NOT STATUTORY, OR EXPRESSED OR IMPLIED, INCLUDING WITHOUT LIMITATION, THE IMPLIED WARRANTIES OF MERCHANTABILITY AND FITNESS FOR A PARTICULAR PURPOSE. THE EXCLUSIVE REMEDY FOR DEFECTIVE FRAME AND COVER SHALL BE ONLY IN CONTRACT, WHETHER OR NOT CAUSED BY A DEFECTIVE FRAME AND COVER, OR NEGLIGENCE. COMPANY’S LIABILITY FOR LOSS OR DAMAGES SHALL NOT EXCEED THE PRICE PAID BY CUSTOMER FOR THE FRAME AND COVER, REGARDLESS OF THE FORM OF ANY CLAIM. IN NO EVENT SHALL COMPANY BE LIABLE FOR ANY SPECIAL, INCIDENTAL, INDIRECT, CONSEQUENTIAL, OR PUNITIVE DAMAGES WHATSOEVER RESULTING FROM ANY DEFECTIVE FRAME AND COVER OR COMPONENT THEREOF. IF MODIFICATION OR ALTERATION IS MADE TO THE FRAME AND COVER OR COMPONENT THEREOF BY OTHER THAN COMPANY AUTHORIZED PERSONS, OR IF IT IS INSTALLED IMPROPERLY, OR MISUSED, ABUSED AND/OR NEGLECTED, THIS LIMITED WARRANTY IS NULL AND VOID AND OF NO EFFECT. THIS LIMITED WARRANTY DOES NOT APPLY AND THE COMPANY WILL HAVE NO RESPONSIBILITY HEREUNDER FOR NORMAL WEAR AND TEAR.**

Halliday Products, Inc.  
6401 Edgewater Dr  
Orlando, FL 32810  
Toll Free: 800-298-1027  
Fax: 407-298-4534  
Email: [Marketing@HallidayProducts.com](mailto:Marketing@HallidayProducts.com)